

Zero 208

ZERO COLLECTION:
Zero 208, Zero 209,

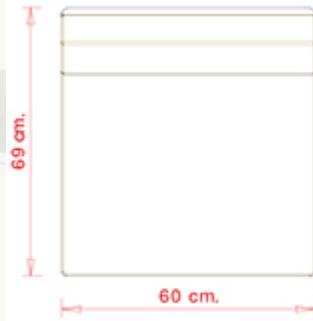
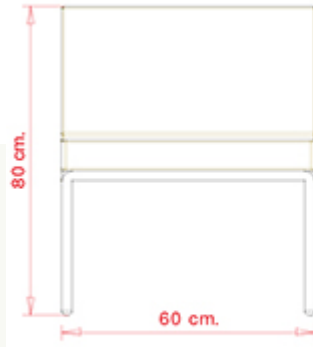

Modular sofa system with painted steel frame and cataphoresistreatment. Fabric for outdoors. Linear module.
*Stackable without cushion

STACKABLE

4*

WEIGHT

7,6 kg

PACK

0,50 m³

PIECES PER BOX

2

FINISHES SEATING

TE FABRICS

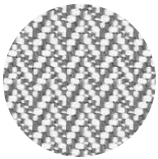

in&out
+ 15 colors

FRAMES

AC STEEL



NCS s0502-b VR
Traffic white



VR Pewter



NCS S0500-N VR
Pure white



NCS S4000-N VR
White aluminium



NCS S7502-B VR
Anthracite grey



NCS S9000-N VR Jet
black



NCS S9000-N VR
Matt Jet Black

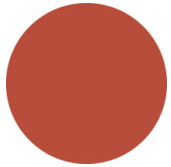

NCS S3060-Y80R
Coral red



VR Rough metallic
bronze

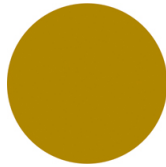

NCS S3060-Y Curry



NCS S4050-B40G
Water blue

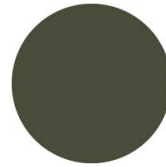

NCS S7020-G50Y
Olive green

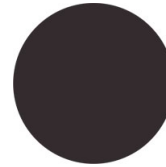

NCS S8005-Y20R
Brown

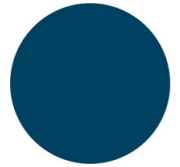

NCS S6030-B
Capri blue



USES

coffee & restaurants, hotels, educational, entertainment,

Zero 209

ZERO COLLECTION:
Zero 208, Zero 209,

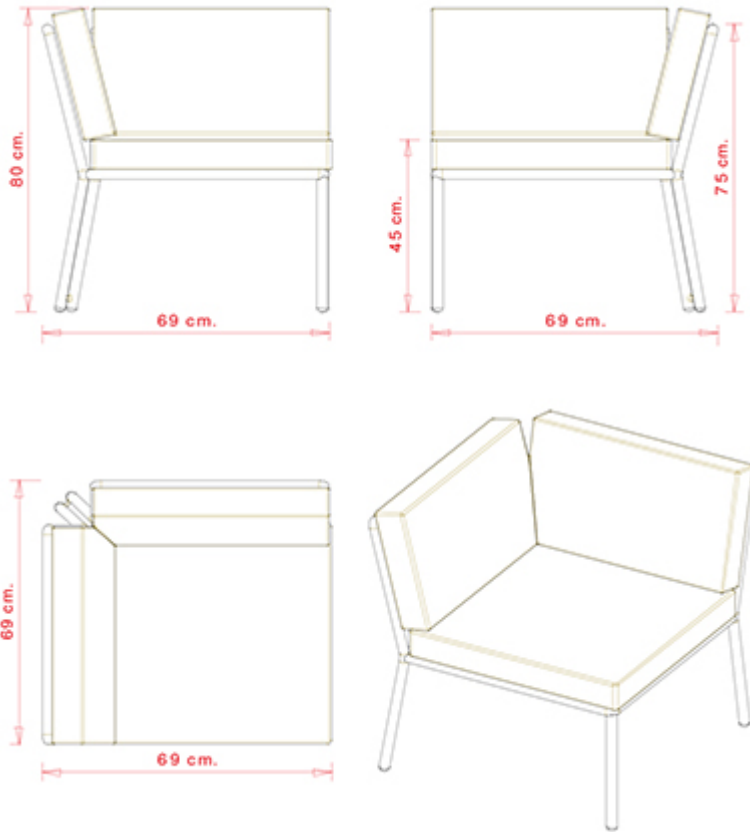

Modular sofa system with painted steel frame and cataphoresistreatment. Fabric for outdoors.
Corner module.
*Stackable without cushion

STACKABLE

2*

WEIGHT

10,2 kg

PACK

0,45 m³

PIECES PER BOX

2

FINISHES SEATING

TE FABRICS

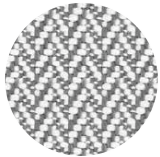

in&out
+ 15 colors

FRAMES

AC STEEL



NCS s0502-b VR
Traffic white



VR Pewter



NCS S0500-N VR
Pure white



NCS S4000-N VR
White aluminium



NCS S7502-B VR
Anthracite grey



NCS S9000-N VR Jet
black



NCS S9000-N VR
Matt Jet Black

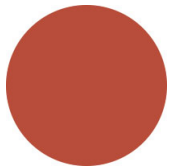

NCS S3060-Y80R
Coral red



VR Rough metallic
bronze

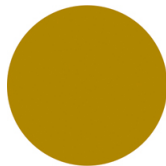

NCS S3060-Y Curry



NCS S4050-B40G
Water blue



NCS S7020-G50Y
Olive green

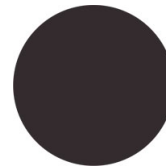

NCS S8005-Y20R
Brown

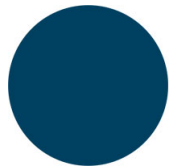

NCS S6030-B
Capri blue



USES

coffee & restaurants, hotels, educational, entertainment,