

AX 512

AX COLLECTION:

AX 511, AX 511A, AX 512, AX 512A, AX 513, AX 514,

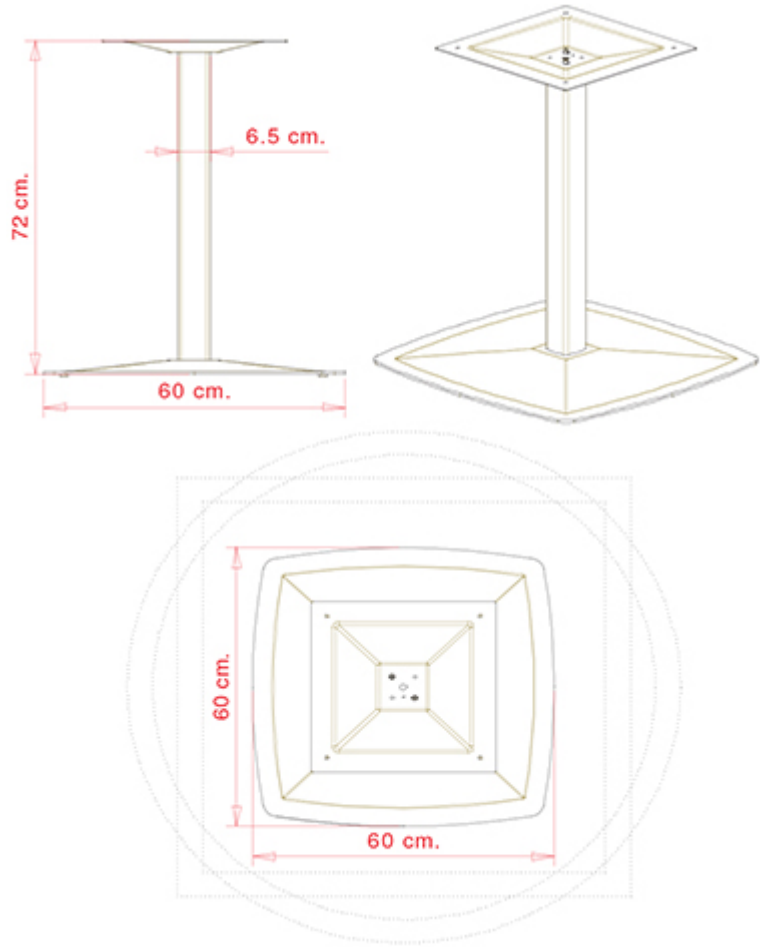

TABLE TOPS:

Ø 100 cm

Ø 110 cm

80x80 cm

90x90 cm

Table frame with moulded steel base and aluminium column.

Accessories: Outdoor version

Accessories: H 12 mm adjustable feet



WEIGHT

21,2 Kg

PACK

0,07 m³

PIECES PER BOX

1

NOTE

Resources

3ds



dwg



Rdm

FRAMES

AL VR PAINTED ALUMINIUM



NCS s0502-b VR Traffic white
≡



NCS S0500-N VR Pure white
≡

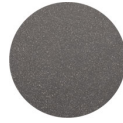

VR Pewter
≡



NCS S4000-N VR White aluminium
≡



NCS S7502-B VR Anthracite grey
≡



VR Rough metallic bronze
≡



NCS S9000-N VR Matt Jet Black
≡



NCS S9000-N VR Jet black
≡

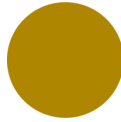

NCS S3060-Y Curry



NCS S4040-R Marsala
≡

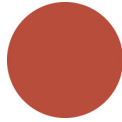

NCS S3060-Y80R Coral red



NCS S4050-B40G Water blue



NCS S7020-G50Y Olive green
≡



NCS S8005-Y20R Brown
≡



NCS S6030-B Capri blue
≡

AC STEEL



NCS S4000-N VR White aluminium
☀



NCS S9000-N VR Jet black
☀

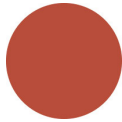

NCS S3060-Y80R Coral red
☀



NCS S9000-N VR Matt Jet Black
☀



VR Rough metallic bronze
☀

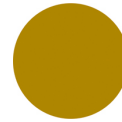

NCS S3060-Y Curry
☀



NCS S7020-G50Y Olive green
☀



NCS S4050-B40G Water blue
☀



NCS S6030-B Capri blue
☀



NCS S8005-Y20R Brown
☀



NCS s0502-b VR Traffic white
☀



NCS S4040-R Marsala
☀

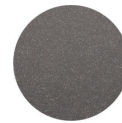

VR Pewter
☀



NCS S0500-N VR Pure white
☀



NCS S7502-B VR Anthracite grey
☀

USES

coffee & restaurants, hotels, educational, entertainment, travel, office and waiting areas, retail, health care, outdoor,