

Harvey 1130

HARVEY COLLECTION:
Harvey 1130,

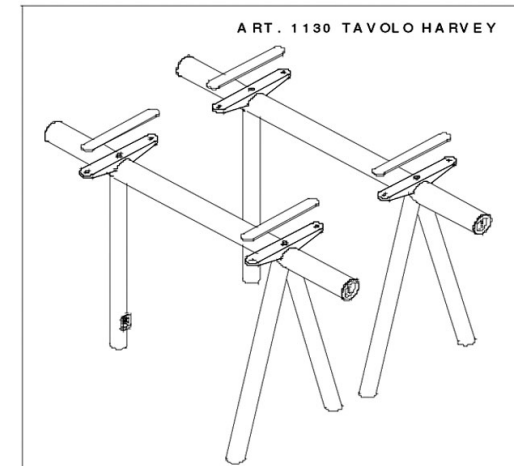
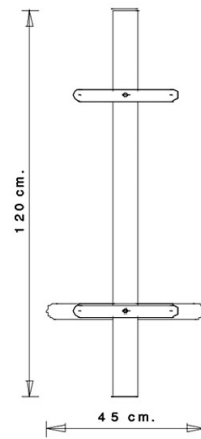
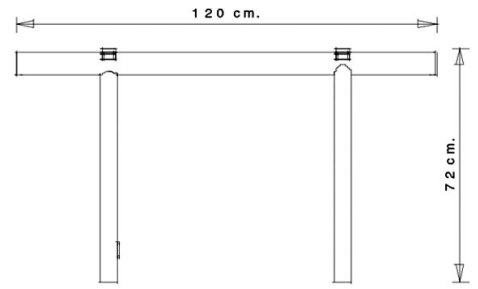
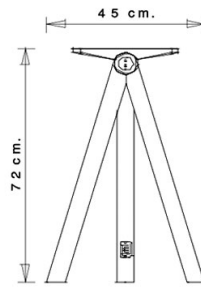

n.2 steel tube easels with support for table top fixing in cast aluminum.
Each easel is equipped with 1 schuko socket and 2 USB sockets.

Table top
300x120 | round and squared edge
240x120 | squared edge

WEIGHT

18,6 Kg

PACK

0,74 m³

PIECES PER BOX

2

FINISHES TABLE TOPS FINISHES

LAM - cat.J LAMINATE - CAT. J



Arpa 20 White
fin.erre

LAM - cat.H LAMINATE - CAT. H



Fenix NTM0720
Nero Ingo
Anti-fingerprints - cat H

FRAMES

AC STEEL



NCS s0502-b VR
Traffic white



VR Pewter



NCS S0500-N VR
Pure white



NCS S4000-N VR
White aluminium



NCS S7502-B VR
Anthracite grey



NCS S9000-N VR Jet
black



NCS S9000-N VR
Matt Jet Black

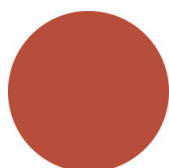

NCS S3060-Y80R
Coral red



VR Rough metallic
bronze

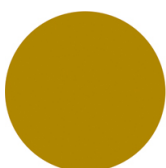

NCS S3060-Y Curry



NCS S4050-B40G
Water blue



NCS S7020-G50Y
Olive green

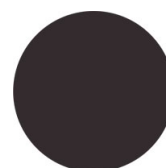

NCS S8005-Y20R
Brown

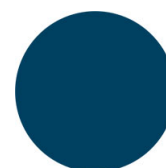

NCS S6030-B
Capri blue



USES

coffee & restaurants, educational, office and waiting areas,