

MT 481A

MT COLLECTION:

MT 481, MT 481A, MT 481F, MT 481A F, MT 482, MT 482A, MT 483, MT 483A, MT 484, MT 484A, MT 491 Q, MT 491A Q, MT 491 T, MT 491A T, MT 493, MT 498 Q, MT 497, MT 497 A, MT 498A Q, MT 498 T, MT 499 Q, MT 499A Q, MT 499 T, MT 499A T, MT 498A T,

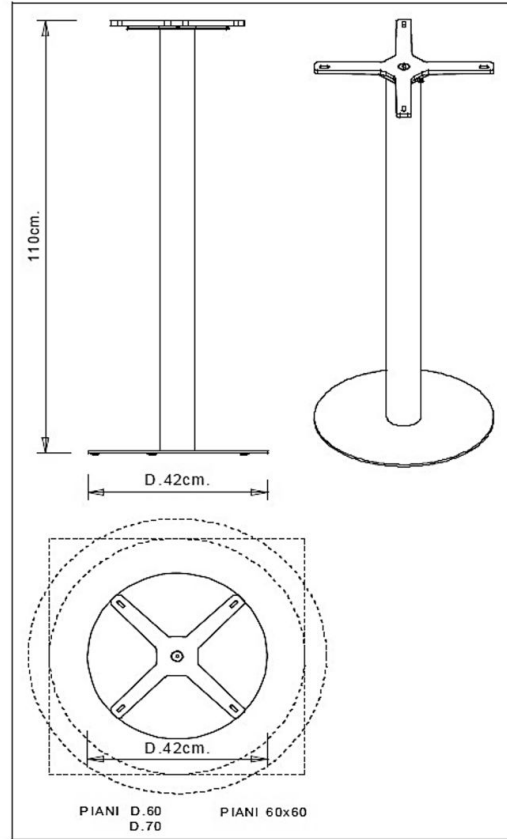
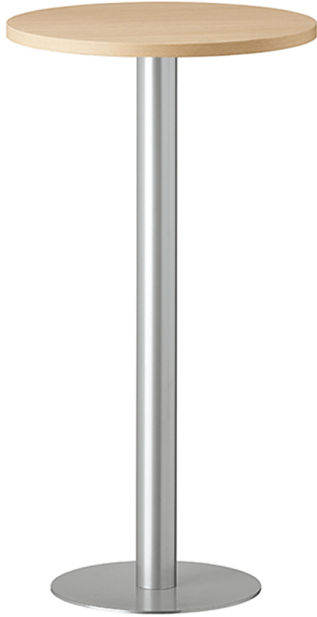

TABLE TOPS: Ø 60 cm Ø 70 cm
60x60 cm

Table frame in painted steel. Available with steel or wood column.

WEIGHT

12,3 kg

PACK

0,05 m³

PIECES PER BOX

2

NOTE

Resources

[3ds](#)



| [dwg](#)



Optional: H 12 mm adjustable feet

FRAMES

LE WOOD



Beech | Honey stained



Beech | Chesnut stained



Beech | Grey stained

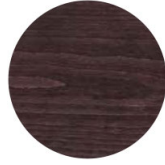

Beech | Dark brown stained



beech | Black stained

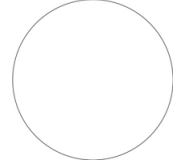

Beech | Stained according to sample

AC STEEL



NCS S4000-N VR
White aluminium
☀️



NCS S9000-N VR Jet
black
☀️

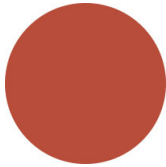

NCS S3060-Y80R
Coral red
☀️



NCS S9000-N VR Matt
Jet Black
☀️



VR Rough metallic
bronze
☀️

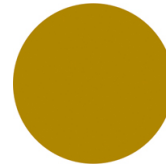

NCS S3060-Y Curry
☀️



NCS S7020-G50Y
Olive green
☀️



NCS S4050-B40G
Water blue
☀️

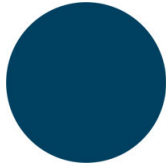

NCS S6030-B
Capri blue
☀️



NCS S8005-Y20R
Brown
☀️



NCS s0502-b VR
Traffic white
☀️

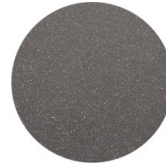

VR Pewter
☀️



NCS S0500-N VR
Pure white
☀️



NCS S7502-B VR
Anthracite grey
☀️

USES

coffee & restaurants, hotels, educational, entertainment, travel, office and waiting areas, retail, health care,