

Dunk 1191

DUNK COLLECTION:

Dunk 1191, Dunk 1190, Dunk 1191m, Dunk 1191n, Dunk 1192, Dunk 1192m, Dunk 1192n, Dunk 1193, Dunk 1193m, Dunk 1193n, Dunk 1194, Dunk 1194m, Dunk 1194n, Dunk 1195m, Dunk 1195, Dunk 1195n, Dunk 1196, Dunk 1196m, Dunk 1196n,

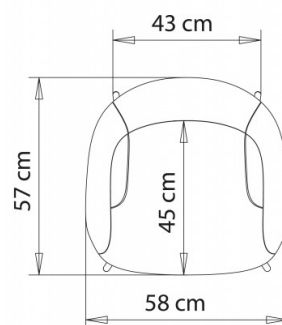
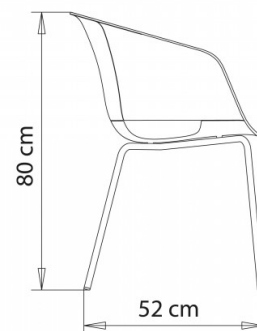
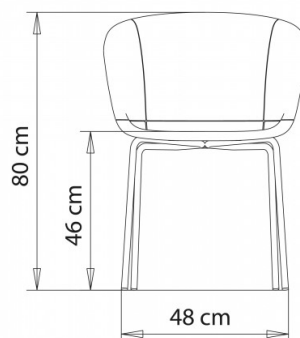

POLTRONCINA DESIGN:

Poltroncina, scocca in versione chiusa, telaio 4 gambe in tubo acciaio.

PESO

5,6 Kg

IMBALLO

0,32 m³

PEZZI PER SCATOLA

1

FINITURE SEDUTE

PP POLIPROPILENE

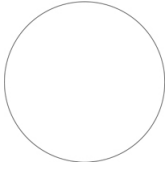

NCS S0502-B
Bianco traffico



NCS S4040-R
Marsala

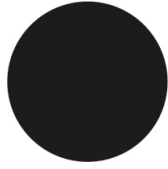



NCS S9000-N
Nero intenso



NOTE

Risorse

[3ds](#)  | [dwg](#) 

Note

La scocca di colore marsala, presente in versione chiusa e aperta, è realizzata con polipropilene riciclato r-PP (recycled PP) proveniente dalla selezione di imballaggi e prodotti alla fine del loro ciclo di vita.

TELAI

AC ACCIAIO



VR Peltro
☀



NCS S0500-N VR
bianco puro
☀



NCS S7502-B VR
Grigio antracite
☀



NCS S4000-N VR
Alluminio brillante
☀



NCS S9000-N VR Nero
intenso
☀



CR Cromato

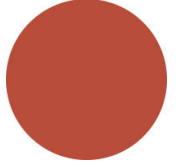

NCS S3060-Y80R
Rosso Corallo
☀



NCS S9000-N VR Nero
intenso opaco
☀



VR Bronzo metallico
bucciato
☀

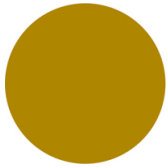

NCS S3060-Y
Giallo curry
☀



NCS S7020-G50Y
Verde oliva
☀



NCS S4050-B40G
Blu acqua
☀

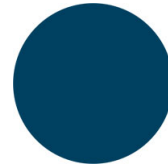

NCS S6030-B
Blu capri
☀



NCS S8005-Y20R
Marrone
☀



NCS s0502-b VR Bianco
traffico
☀

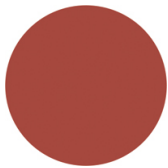

NCS S4040-R
Marsala
☀

DESTINAZIONI D'USO

Coffee & Restaurants, Hotels, Educational, Entertainment, Travel, Office and Waiting Areas, Retail, Health Care, Outdoor,